

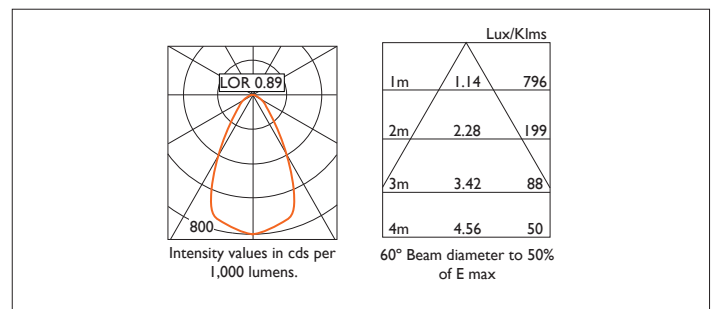

QUAD X86 DOUBLE

QUAD 86 DIRECTIONAL SQUARE OBLONG Recessed downlighter with a choice of ceiling trim, black interior finish and beam distribution. 0-30° tilt, 340° rotation. Overall dimension 86mm x 86mm, cut out 77 x 77mm. Xicato LED.

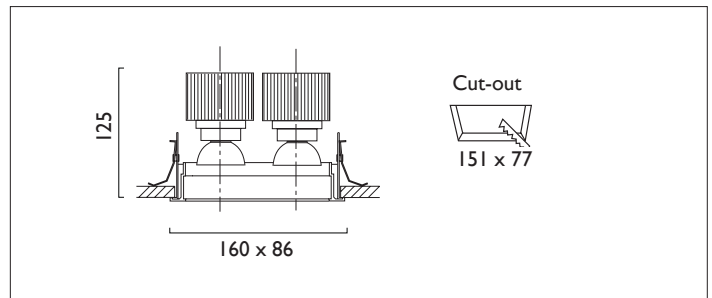

Product Number	C2260/*Engine
Lamp Type	Xicato LED, Up to 2 x 2000 lumens
Beam Angle	60°
Construction	Aluminium / Steel
Ceiling Trim	White RAL 9010
IP	IP44
Control	Driver

Please Note: For lumen output/power, colour temperature and protocols and appropriate Light Engine should also be specified.

*Light Engine Specification

Xicato XTM L80 50,000 hours >Ra80

07A	720 lm	4.5W	160 lm/w	350mA
09A	965 lm	6.6W	146 lm/w	500mA
13A	1300 lm	9.5W	137 lm/w	700mA
14A	1490 lm	10.6W	141 lm/w	500mA
20A	2000 lm	15.2W	131 lm/w	700mA

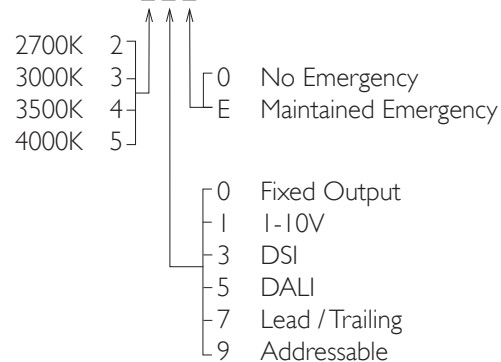

EN 60598-1
WEE/AE0290TY

